

UHPX-5800-30-06-DP

UHPX-5800-32-09-DP

UHPX-5800-35-12-DP



UHPX-5800-30-06-DP

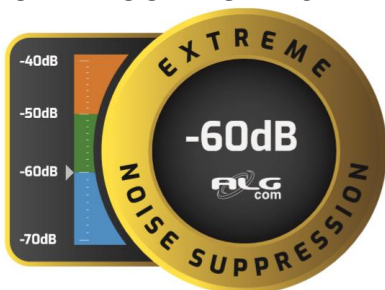

UHPX-5800-32-09-DP

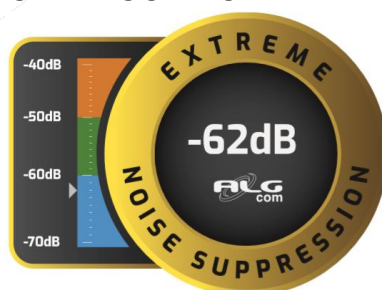

UHPX-5800-35-12-DP

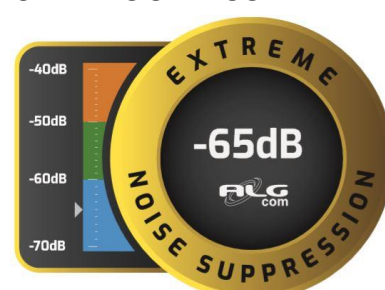

# PARÁBOLA FULL BAND EXTREME

EXTREME FULL BAND PARABOLIC ANTENNA

PARÁBOLA RANGO EXTENDIDO EXTREME

## UHP - X

- *Incrível largura de banda: 4.9 - 6.425 GHz*

*Incredible bandwidth: 4.9 - 6.425 GHz*

*Increíble rango de frecuencia: 4.9 - 6.425 GHz*

- *Antena para Ponto a Ponto com Ultra High Performance e Extrema rejeição de ruído*

*Point to Point antenna with Ultra High Performance and Extreme noise rejection*

*Antena para Punto a Punto con Ultra High Performance y Extremo rechazo del ruido*

- *Excepcional VSWR e Isolação entre portas*

*Outstanding VSWR and Port-to-port isolation*

*Excepcional VSWR y Aislamiento entre puertos*



Tecnologia para enlaces profissionais  
Technology for professional links  
Tecnología para enlaces profesionales

## CARACTERÍSTICAS ELÉTRICAS

### ELECTRICAL SPECIFICATIONS/CARACTERÍSTICAS ELÉCTRICAS

UHPX-5800-XX-XX-DP	30-06	32-09	35-12
<b>Frequência de operação</b> Frequency range/Rango de operación	4.9 – 6.425 GHz		
<b>Diâmetro</b> Diameter/Diámetro	0.6 m	0.9 m	1.2 m
<b>Ganho Banda Alta</b> Gain High Band/Ganancia banda alta	30.5 dBi	33.2 dBi	36.0 dBi
<b>Ganho Banda Média</b> Gain Mid band/ Ganancia Banda media	29.5 dBi	32.5 dBi	34.8 dBi
<b>Ganho Banda Baixa</b> Gain Low band/ Ganancia Banda baja	28.5 dBi	30.0 dBi	33.1 dBi
<b>Ângulo de meia potência</b> Beamwidth/Ángulo de media potencia	5.8°	3.1°	2.4°
<b>Relação frente-costas (165° - 180°)</b> Front-to-back ratio/Relación frente espalda	>55 dB	>59 dB	>62 dB
<b>Isolação por polarização cruzada</b> XPD/Aislamiento de polarización cruzada	>30 dB		
<b>VSWR</b>	1.6:1 (max) 1.5:1 (typ)		
<b>Isolação entre portas</b> Port-to-Port Isolation/Aislamiento entre puertos	>30 dB		
<b>Polarização</b> Polarization/Polarización	Dupla (V e H ou +/- 45°) Double (V and H or +/- 45°) Doble (V y H o +/- 45°)		
<b>Conexão</b> Antenna input/Conexión	N fêmea ou SMA Fêmea Reverso N female or SMA Female reverse N Hembra o SMA Hembra reverso		

## CARACTERÍSTICAS MECÂNICAS

### MECHANICAL SPECIFICATIONS/CARACTERÍSTICAS MECÂNICAS

UHPX-5800-XX-XX-DP	30-06	32-09	35-12
<b>Ajuste de elevação</b> Elevation adjustment/Ajuste de elevación	+/- 15°		+/- 10°
<b>Ajuste de azimute</b> Azimuth adjustment/Ajuste de azimut	+/- 18°		+/- 25°
<b>Ajuste de polarização</b> Polarization adjustment/Ajuste de polarización		+/- 5°	
<b>Peso da antena</b> Weight/Peso	12.5 kg	18.2 kg	31.5 kg
<b>Fixação em mastro</b> Mounting pipe diameter/Fijación en mástil	Ø2" - Ø4.1/2"		Ø3" - Ø4.1/2"
<b>Vento operacional</b> Operational windspeed/Viento operativo	110 km/h		
<b>Vento de sobrevivência</b> Survival windspeed/Viento de supervivencia	200 km/h		
<b>Área de vento (m²)</b> Wind área(m²)/Área de viento(m²)	0.393	0.698	1.393



#### MAIOR BLINDAGEM BETTER SHIELDING / MÁS BLINDAJE

Refletor deep dish que atua em conjunto com o shield, fazendo com que as parábolas UHPX sejam perfeitas para instalação em locais com bastante ruído e interferência.

The deep dish reflector and the shield make the UHPX Antennas perfect for installation in places with a lot of noise and interference.

El deep dish y el shield hacen que las parábolas UHPX sean perfectas para la instalación en lugares con mucho ruido e interferencia.



#### MONTAGEM RÁPIDA E FÁCIL QUICK AND EASY ASSEMBLY / MONTAJE

Metade do tempo em comparação com modelos anteriores.

Results in half the time compared to previous models.

En la mitad del tiempo en comparación con los modelos anteriores.



#### POLARIZAÇÃO SLANT SLANT POLARIZATION / POLARIZACIÓN SLANT

Proporciona maior flexibilidade em enlases de dupla polarização, com a possibilidade de instalação V / H ou +/- 45°.

Provides greater flexibility in double polarized links, with the possibility of V / H or +/- 45° installation.

Proporciona mayor flexibilidad en conexiones de doble polarización con la posibilidad de instalación V / H o +/- 45°.



#### NOVO TAMANHO NEW SIZE / NUEVO TAMAÑO

As parábolas UHPX estarão disponíveis em três tamanhos; O novo tamanho de 1,20m permite que sejam feitos enlases mais longos com a mesma qualidade.

The antennas will be available in three sizes and the new 3.9 ft allows longer links to be made with the same quality.

Las parábolas estarán disponibles en tres tamaños y el nuevo 1,2m permite hacer enlases más largos con la misma calidad.

## DIAGRAMA DE RADIAÇÃO RADIATION PATTERN/DIAGRAMA DE RADIACIÓN

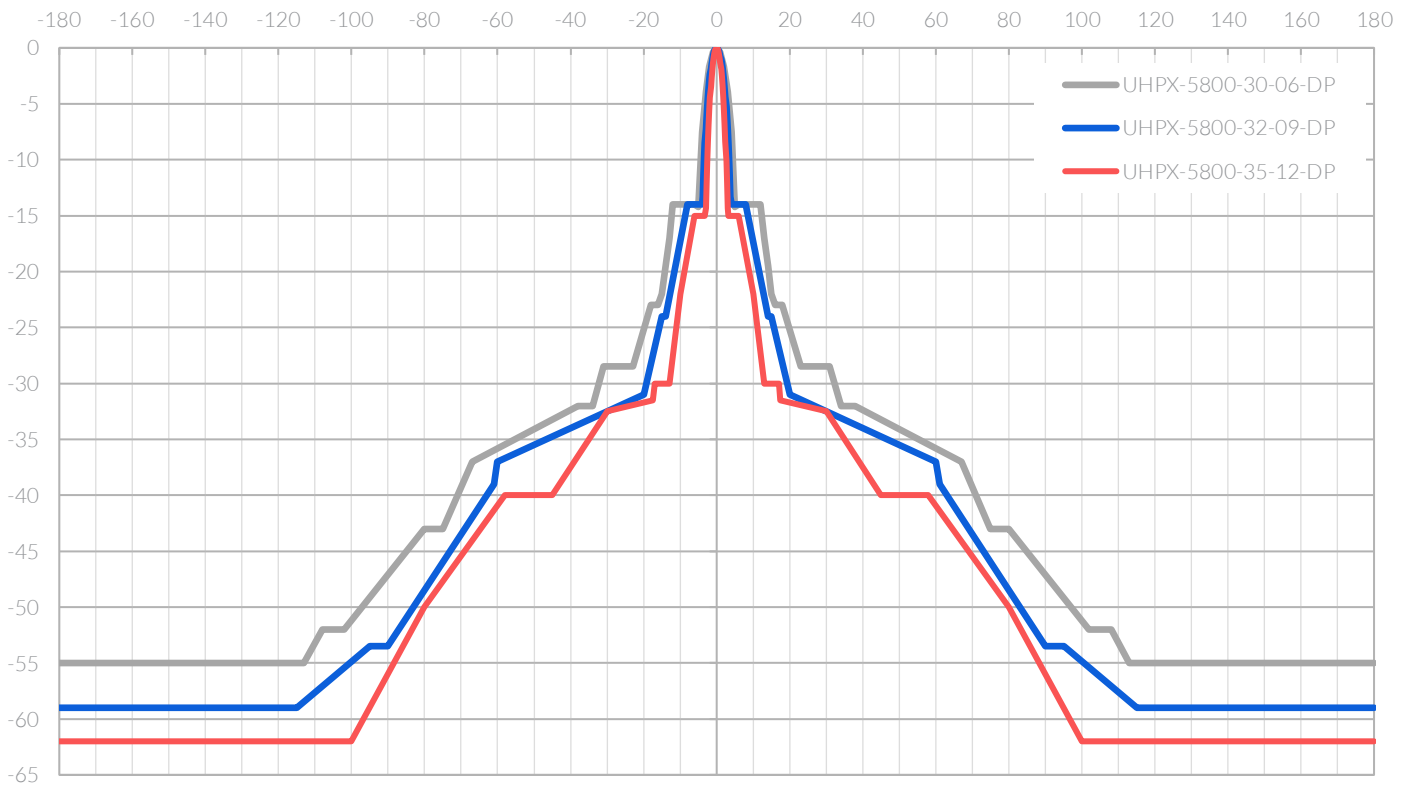

## CURVA DE GANHO GAIN OVER FREQUENCY/ GRÁFICA DE GANANCIA

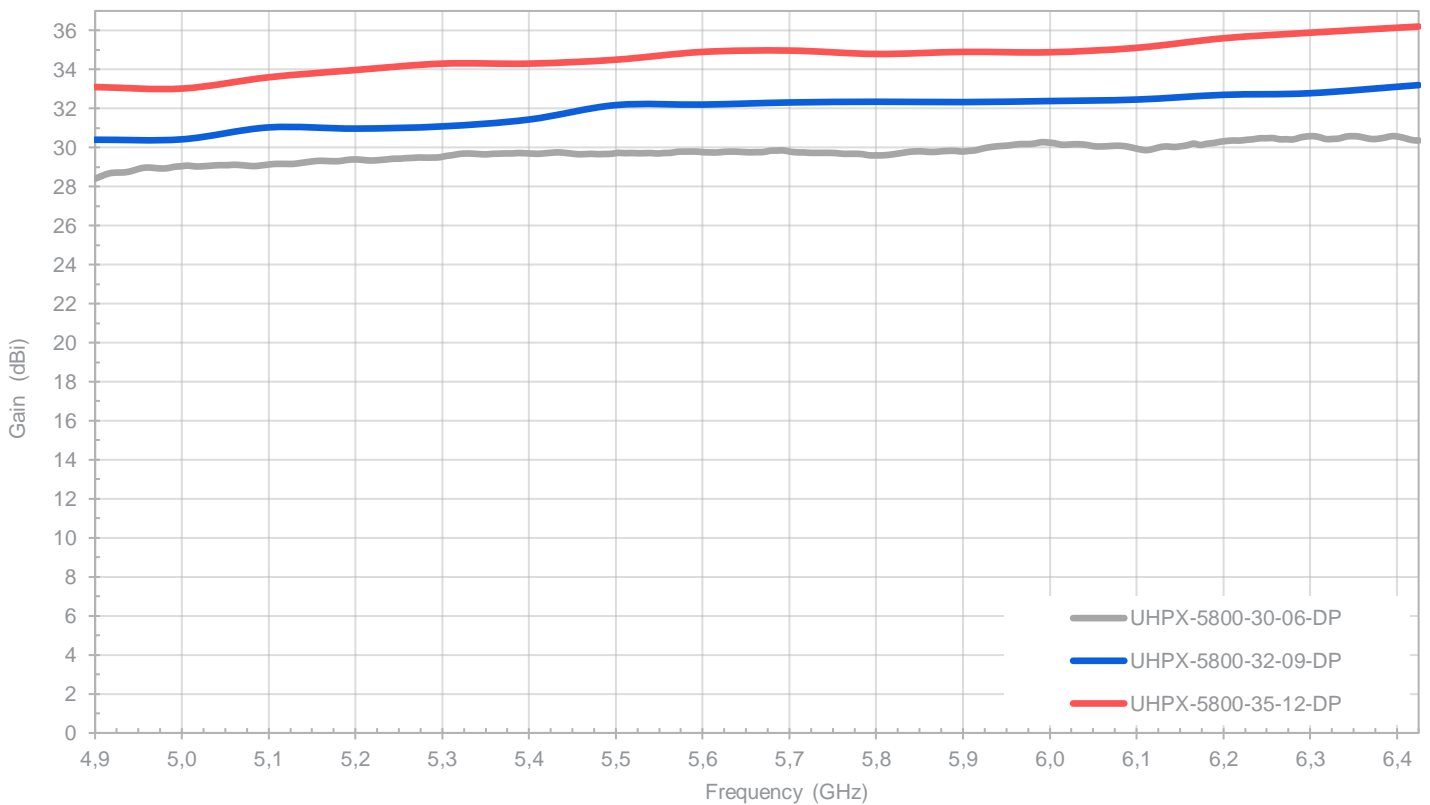

## DIMENSÕES

### DIMENSIONS / DIMENSIONES

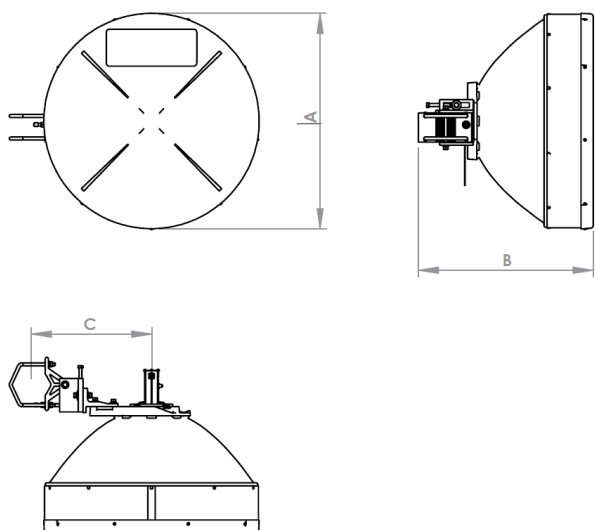

UHPX-5800-XX-XX-DP	30-06	32-09	35-12
<b>A</b>	708 mm	943 mm	1332 mm
<b>B</b>	570 mm	723 mm	875 mm
<b>C</b>	396 mm	396 mm	390 mm

## EMBALAGEM

### PACKAGE / EMBALAJE

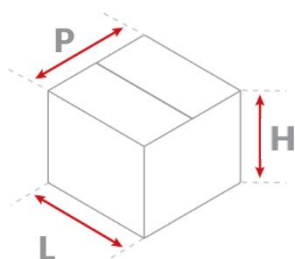

UHPX-5800-XX-XX-DP	30-06	32-09	35-12
<b>L</b>	740 mm	1020 mm	611 mm
<b>P</b>	740 mm	1020 mm	1446 mm
<b>H</b>	530 mm	510 mm	1510 mm
<b>Volume/Volume/Volumen</b>	0.29 m <sup>3</sup>	0.53 m <sup>3</sup>	1.42 m <sup>3</sup>
<b>Peso embalado/Packed weight/Peso embalado</b>	17 kg	25.6 kg	70.5 kg
<b>Material/Material/Material</b>	Papeloão/Cardboard/Cartón		Madeira/Wood/Madera



Tecnologia para enlaces profissionais  
Technology for professional links  
Tecnología para enlaces profesionales

*Transformando ideias em futuro*  
*Transforming ideas into future*  
*Transformando ideas en futuro*

+55 54 3201.1903 | [algcom@algcom.com.br](mailto:algcom@algcom.com.br)

Ernesto Zanrosso, 3440 | Caxias do Sul - RS | Brasil | [www.algcom.com.br](http://www.algcom.com.br)

